

QUANTUM CS50

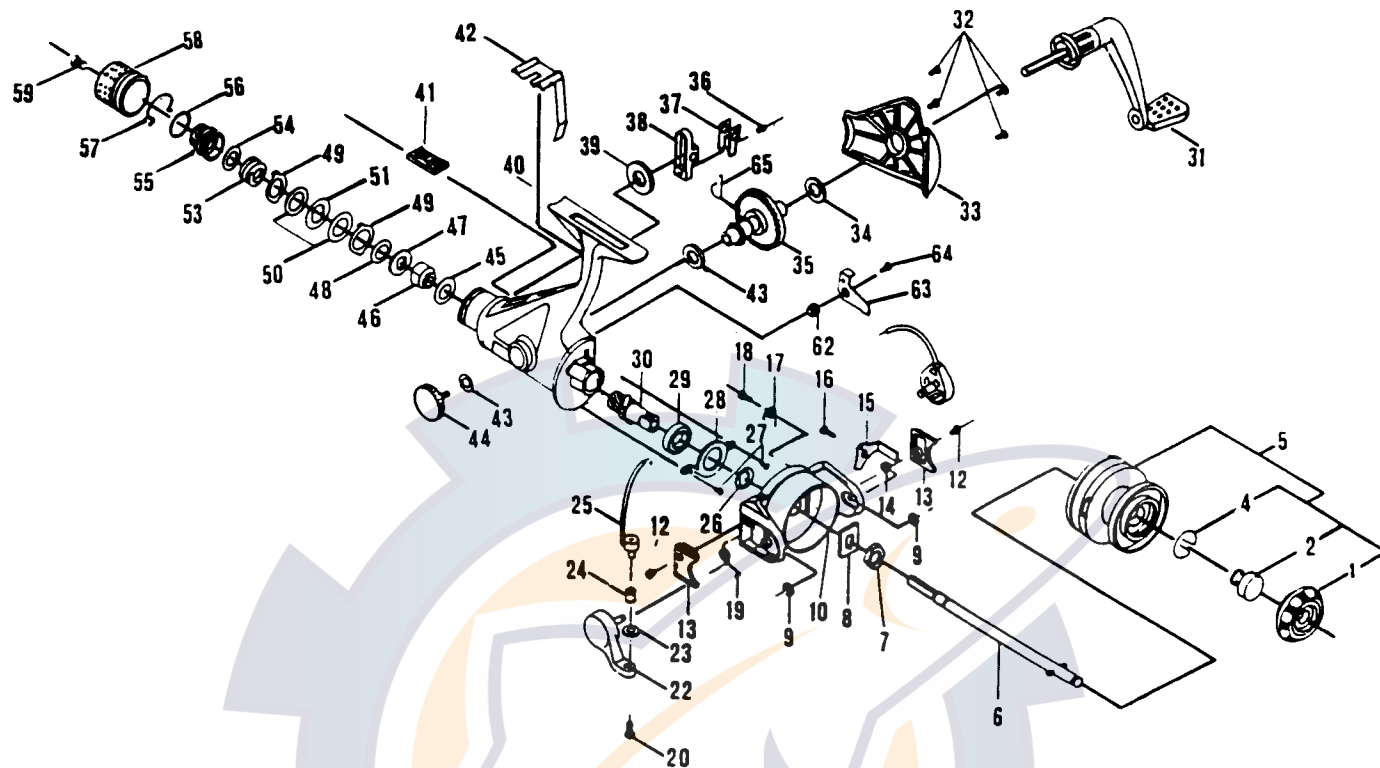

Key No.	Part No.	Description	Price	Key No.	Part No.	Description	Price
1	YQ032-4	Spool Cap	1.60	33	YQ023-5	Cover Plate	8.14
2	YQ402-2	Spool Release Button	1.24	34	YQ157-2	Drive Gear Bushing	1.13
4	YQ038-2	Spool Locking Spring	1.13	35	YQ012-3	Drive Gear	3.35
5	YQ321-5	Spool	7.98	36	YQ081-3	Holder Screw	.62
6	YQ015-4	Main Shaft	2.63	37	YQ059-3	Lever Wind Hold	1.13
7	YQ006-2	Pickup Housing Nut	.93	38	YQ084-3	Lever Wind Bracket	1.49
8	YQ105-2	Pickup Housing Washer	1.13	39	YQ085-4	Lever Wind Gear	1.49
9	YQ034-2	Retaining Ring	.62	40	YQ001-5	Frame	9.12
10	YQ009-2	Pickup Housing	7.42	41	YQ065-2	Push Button	1.24
12	YQ077-2	Bracket Cover Screw	.62	42	YQ068-3	Push Button Spring	1.13
13	YQ087-4	Bracket Cover	1.03	43	YQ157-2	Drive Gear Bushing	1.13
14	YQ203-5	Trip Lever Washer	.93	44	YQ073-2	Crank Locking Screw	1.55
15	YQ115-5	Trip Lever	1.24	45	YQ033-2	Front Drag Washer	.93
16	YQ078-2	Trip Lever Screw	.62	46	YQ027-4	Drag Stem	1.13
17	YQ049-3	Trip Lever Spring	.82	48	YQ029-2	Drag Washer	.93
18	YQ079-2	Trip Spring Screw	.62	49	YQ046-2	Eared Drag Washer	1.03
19	YQ022-2	Trip Spring	.93	50	YQ031-2	Drag Washer	.93
20	YQ108-2	Line Roller Screw	1.49	51	YQ030-2	Keyed Drag Washer	.93
22	YQ007-2	Bail Bracket	1.60	53	YQ029-2	Drag Spring	.93
23	YQ017-2	Line Roller Washer	1.13	54	YQ026-2	Drag Spring Washer	.93
24	YQ004-2	Line Roller	1.70	55	YQ050-2	Drag Insert	1.55
25	YQ347-5	Bail Wire	4.27	56	YQ037-3	Wire Washer	1.03
26	YQ126-2	Pinion Washer	.62	57	YQ036-2	Wire Spring	.93
27	YQ080-3	Ball Race Retainer Screw	.62	58	YQ332-5	Drag Knob	1.55
28	YQ040-3	Ball Race Retainer	1.24	59	YQ101-5	Drag Screw	1.03
29	YQ028-3	Ball Race	3.35	62	YQ102-2	N-R Pawl Washer	1.13
30	YQ011-3	Pinion	1.44	63	YQ103-4	N-R Pawl	1.55
31	YQ318-3	Crank Arm	5.46	64	YQ104-2	N-R Pawl Screw	.52
32	YQ057-2	Cover Plate Screw	1.13	65	YQ106-2	N-R Pawl Spring	.93

Prices subject to change without notice. Prices do not include postage and handling.

PLEASE ORDER BY PART NUMBER

Rev. 6/95

Zebco Division Brunswick Corporation, Box 270, Tulsa, OK 74101 USA 918-836-5581

